







DSA15

AUTO-Programming Multiband Amplifier

-  **Built-in DVB-T/T2 tuner for DTT Auto-Programming**
-  **High Selectivity channel filters with ACG**
-  **Lte700 5G SAW filter technology protection**
-  **Autosensing antenna input powering**
-  **ON / OFF Switch DAB enabler**
-  **Integrated high-efficiency power supply**
-  **DIN rail and wall mounting**

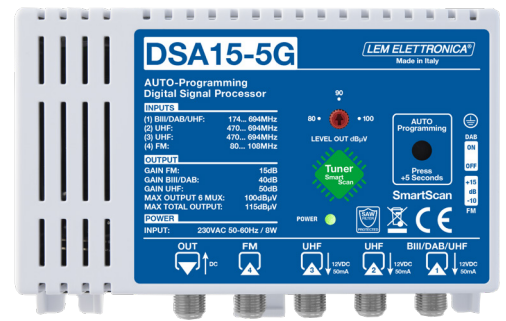

Compact and versatile MATV amplifier for the amplification of terrestrial signals coming from several antennas.

Active device with built-in tuner to detect DVB-T/T2 channels for UHF+VHF inputs, the unit performs an automatic programming of the filters, as well as the appropriate level equalization. The manual adjuster allows the installer to adapt the output level to the characteristics of the distribution network.

The amplifier integrates a high-efficiency low-power consumption switch-mode power supply. Can be also remotely powered over the output coaxial cable.



MODEL		DSA15
NUMBER OF INPUTS		1xFM / 1xBIII/DAB/UHF / 2xUHF
INPUTS FREQUENCY RANGE	MHz	FM (88... 108) BIII (170... 230) / DAB (170... 240) UHF (470... 694)
LTE PROTECTION		LTE 700
SINGLE CHANNEL FILTERS		Up to 32
NUMBER OF CHANNEL PER FILTERS		1
MAXIMUM INPUT LEVEL	dBµV	FM 90 - BIII/DAB 100 - UHF 100
AUTOMATIC GAIN CONTROL RANGE	dB	40 dB
DIGITAL FILTERS SELECTIVITY	dB	35 @1MHz
FM GAIN	dB	-10/+15 (selectable)
BIII/DAB GAIN	dB	40
UHF GAIN	dB	50
OUTPUT LEVEL RANGE	dBµV	80... 100 (adjustable)
RETURN LOSS IN/OUT	dB	>10
REMOTE POWER SUPPLY		12V / 60mA
INPUT VOLTAGE	V	100... 240VAC 50/60Hz
MAXIMUM CONSUMPTION	W	8
OPERATING TEMPERATURE	°C	-15... 40
DIMENSIONS	mm	135 x 91 x 45

Programming & Connection diagram

SmartScan automatic programming

After connecting the antennas, simply press a button to start scanning the signals present in each input. Each received MUX is analyzed using the integrated **DVB-T/T2 Tuner** and is stored only if it has adequate quality requirements. If the same MUX is detected by different antennas, the one with the best quality parameters is chosen.

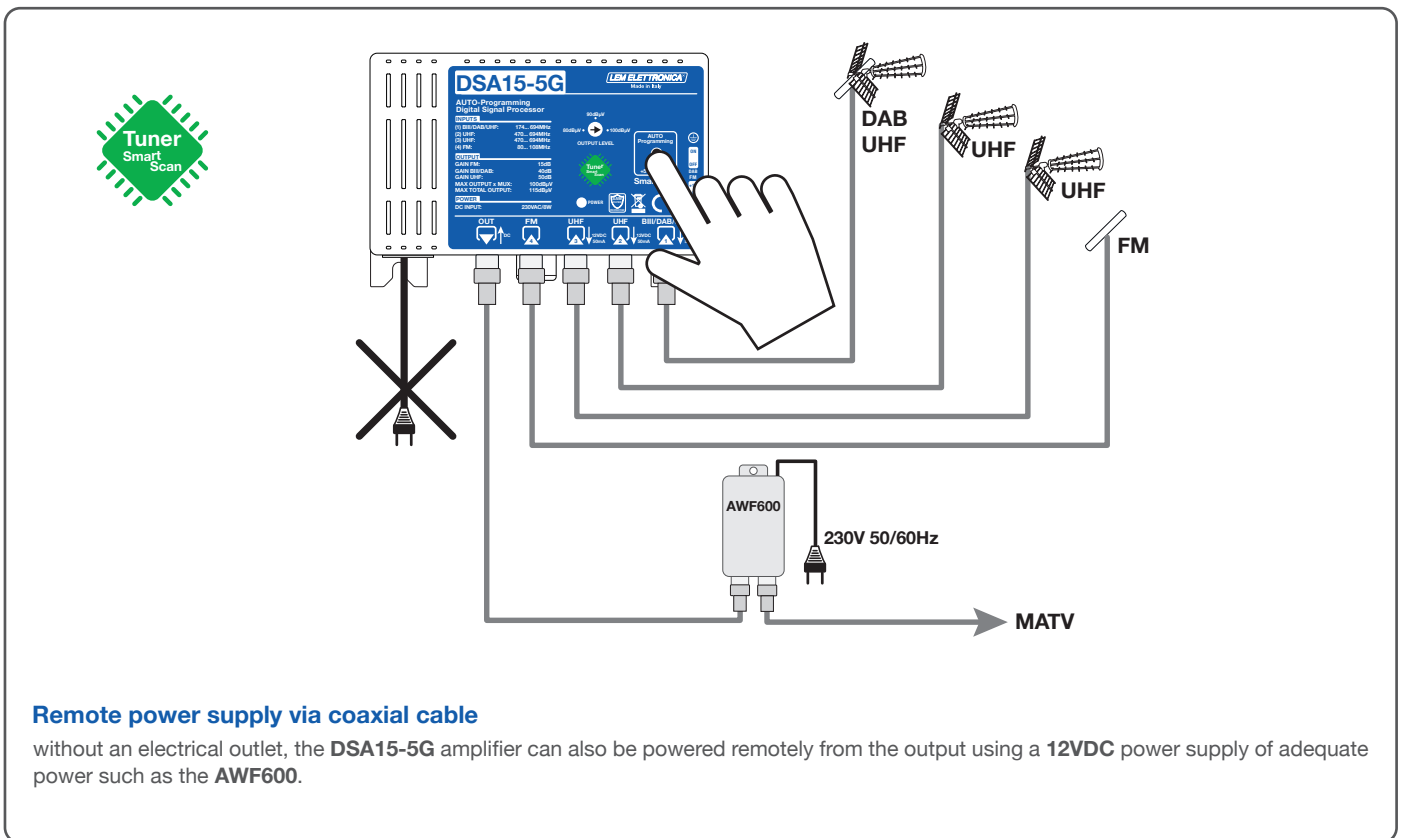
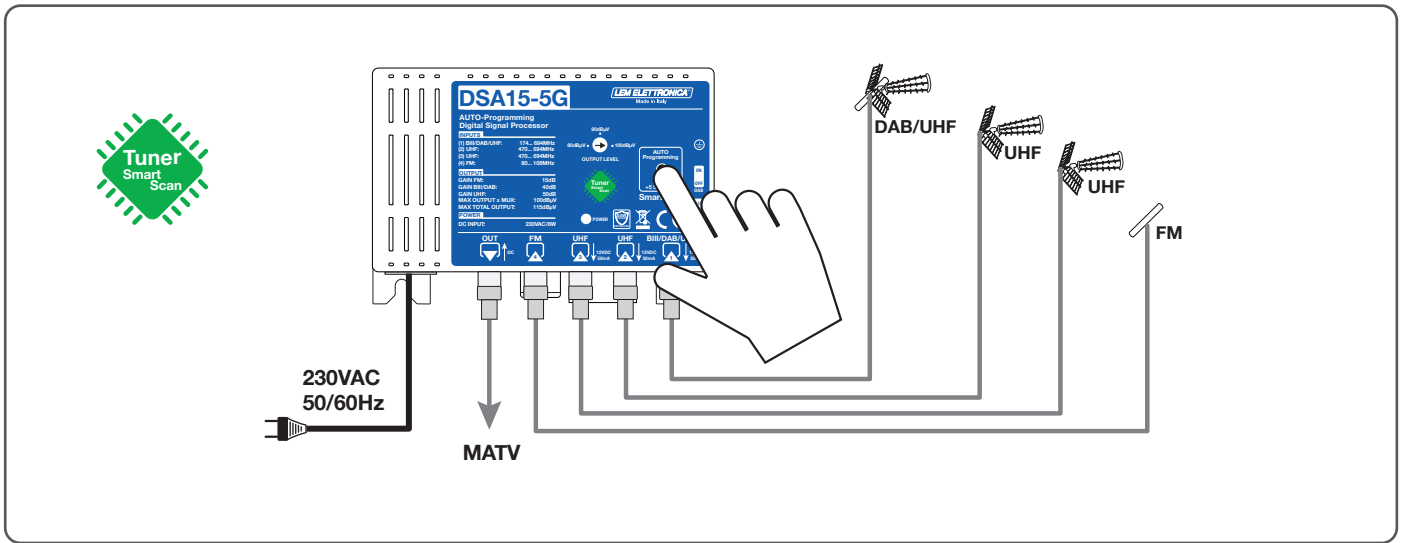

Remote power supply via coaxial cable

without an electrical outlet, the **DSA15-5G** amplifier can also be powered remotely from the output using a **12VDC** power supply of adequate power such as the **AWF600**.

Automatic filter equalization

After completing the search and storage of the received signals, each filter is optimized in amplitude and equalized to guarantee a perfectly linear and balanced output spectrum, reaching the maximum possible output level.

